

Xcel Power|Mate™



PRODUCT PROFILE



Xcel Power|Mate™

Auto-latch mating mechanism provides fast and reliable connection with audible and tactile feedback to confirm that the connector pairs are fully engaged.

Compared to normal push pull connectors, Xcel's sliding ring is sprung automatically into the locked position.

Disconnection is also fast, with holding the sliding ring to pull. Xcel is a low cost plastic connector without shielding.

TUV certified.



KEY FEATURES

- Push-pull locking system
- No tool required to unmate
- Multiple coding positions
- Sealing, IP67 (mated)
- RoHS compliant

MECHANICAL	
Durability	≥ 500 mating cycles
Wire range	1.5 to 16mm ²
Connection type	Crimping
ELECTRICAL	
Rated voltage	500V / 800V AC
Rated current	23A to 63A
Insulator resistance	> 5000MΩ
Dielectric withstand voltage	3000V AC / 3600V AC
Temperature rise	≤ 55°C
Shielding	Unshielded
ENVIRONMENTAL	
Sealing	IP67 (mated)
Temperature range	-40°C to 120°C
Humidity	90% to 95% (40 ± 2°C)
Salt spray	96 hours
MATERIAL	
Terminals	Copper/copper alloy with tin plating
Housing	Thermoplastics

INSERT ARRANGEMENT

Front face of receptacle

Contacts

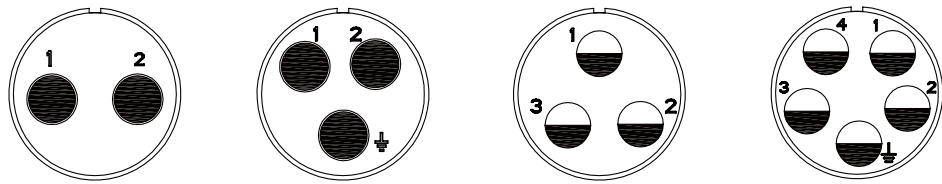
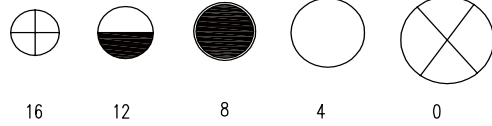

Insert Arrangement	18-02	18-03E	18-03	18-05E
Rated Voltage	800V	500V	800V	500V
Current Rated	45A	45A	23A	23A
Contact Number	2	2+PE	3	4+PE
Contact Size	#8	#8	#12	#12
Withstanding Voltage	3600V	3000V	3600V	3000V

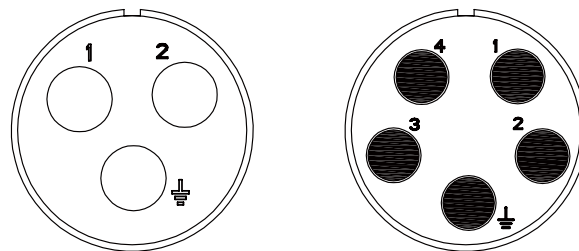

Insert Arrangement	28-03E	28-05E
Rated Voltage	500V	500V
Current Rated	63A	45A
Contact Number	2+PE	4+PE
Contact Size	#4	#8
Withstanding Voltage	3000V	3000V

HOW TO ORDER

	XCEL	6	L	18	02	E	S	C	XXX	/
Shell type: 3: Flange receptacle 6: Straight plug										
Service class: L: Waterproof A: Non waterproof										
Shell size: 18, 28										
Insert arrangement: Refer to page 3										
Earth wire: /: Omit, without grounding pin E: With grounding pin										
Contact type: P: Pin S: Socket										
Contact wire type: C: Crimp M: Screw type										
Cable grand size: PG21: PG21 thread DXX: Cable clamp size Φ XX										
Alternate position: /: Omit, Standard position 105° B: 95° C: 115°										

ALTERNATE POSITION

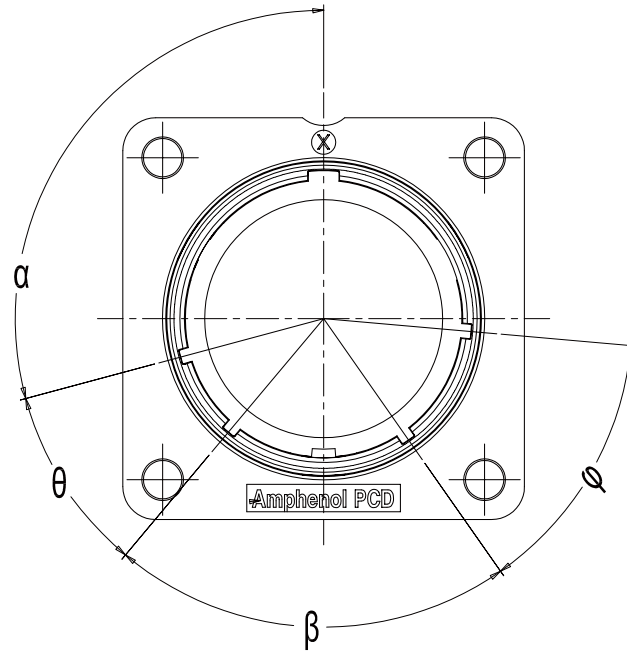

Shell Size	Angles in degree							
	α		θ		β		φ	
	N	B	N	B	N	B	N	B
18	105°	95°	35°	35°	75°	75°	50°	50°
28	105°	95°	35°	35°	75°	75°	50°	50°

18-02: 800V / 45A , 2 PIN CONNECTOR



RECEPTACLE

P/N: XCEL3A1802PCLC

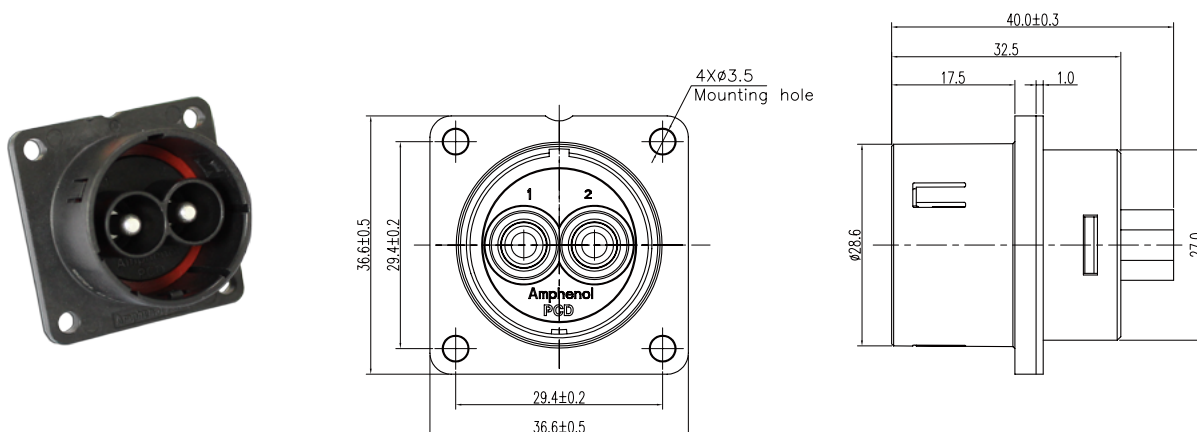

PLUG

P/N: XCEL6L1802SCPG21LC

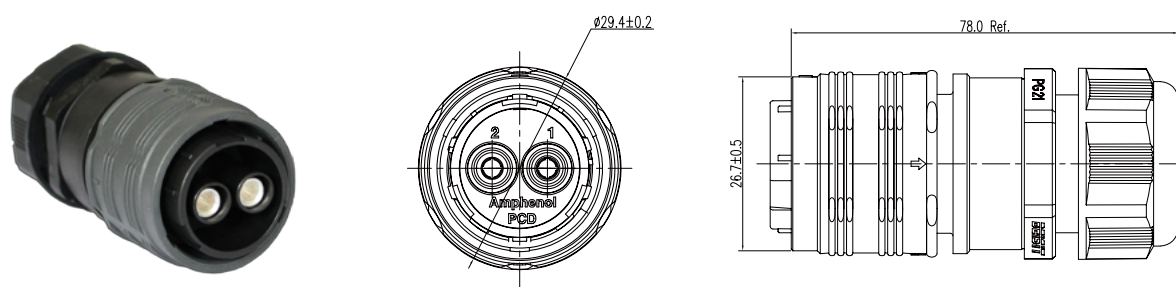

Technical data

Insert arrangement	18-02
Rated voltage	AC 800V
Rated current	45A
Contacts	2 X #8
Crimping cable	8 to 10mm ²

18-03: 800V / 23A , 3 PIN CONNECTOR



RECEPTACLE

P/N: XCEL3A1803PCLC

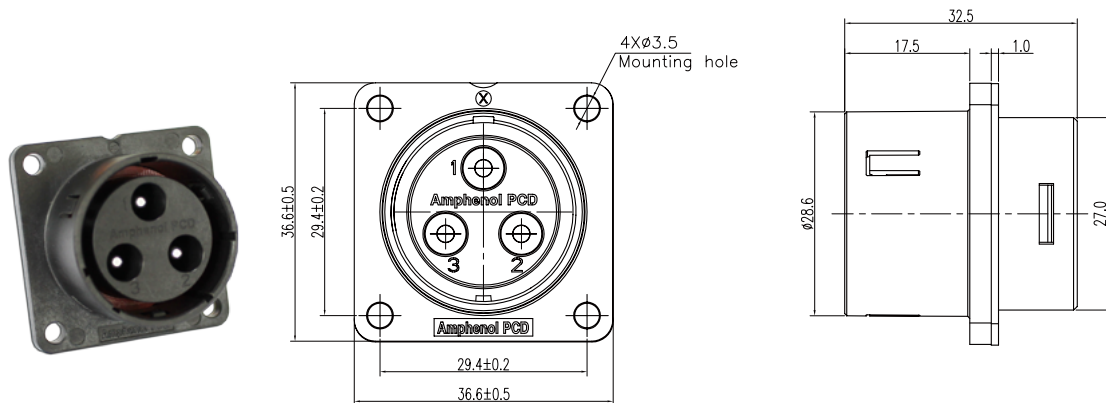

PLUG

P/N: XCEL6L1803SCPG21LC

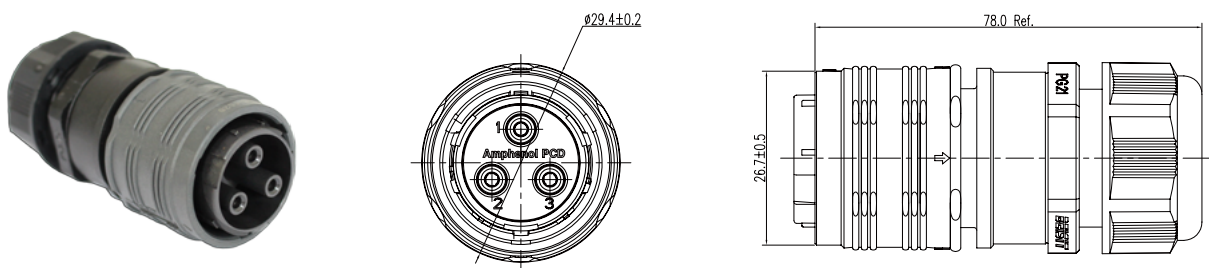

Technical data

Insert arrangement	18-03
Rated voltage	AC 800V
Rated current	23A
Contacts	3 X #12
Crimping cable	1.5 to 2.5mm ²

18-03E: 500V / 45A , 3 PIN CONNECTOR

RECEPTACLE

P/N: XCEL3A1803EPCLC

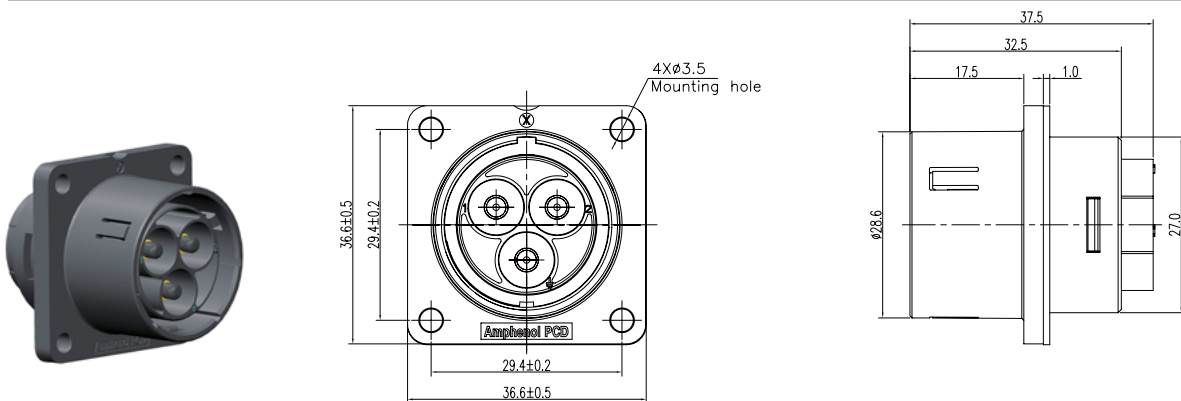

PLUG

P/N: XCEL6L1803ESCXXLC

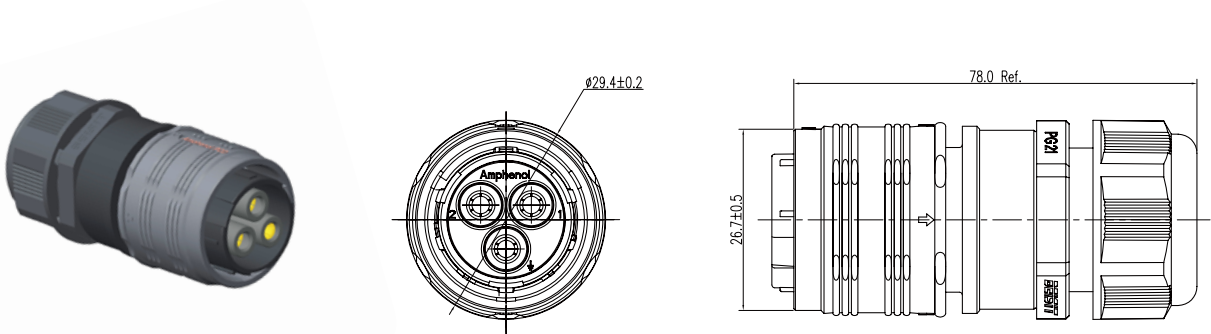

Technical data

Insert arrangement	18-03E
Rated voltage	AC 500V
Rated current	45A
Contacts	3 X #8
Crimping cable	5 to 6mm ²

18-05: 500V / 23A , 5 PIN CONNECTOR

RECEPTACLE

P/N: XCEL3A1805EPCLC

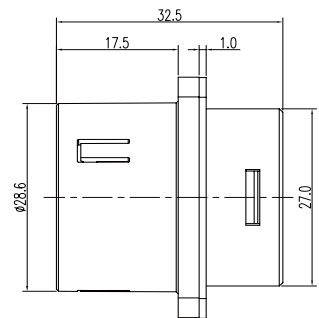
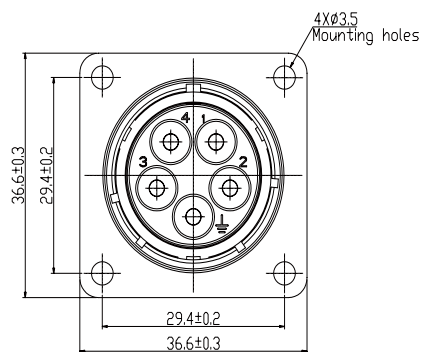

PLUG

P/N: XCEL6L1805ESCXXLC

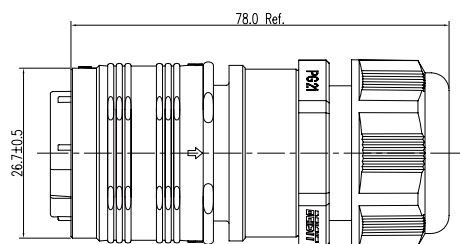
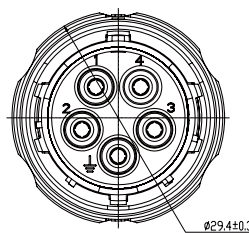

Technical data

Insert arrangement	18-05
Rated voltage	AC 500V
Rated current	23A
Contacts	5 X #12
Crimping cable	1.5 to 2.5mm ²

28-03E: 500V / 63A , 3 PIN CONNECTOR

RECEPTACLE

P/N: XCEL3A2803EPCLC

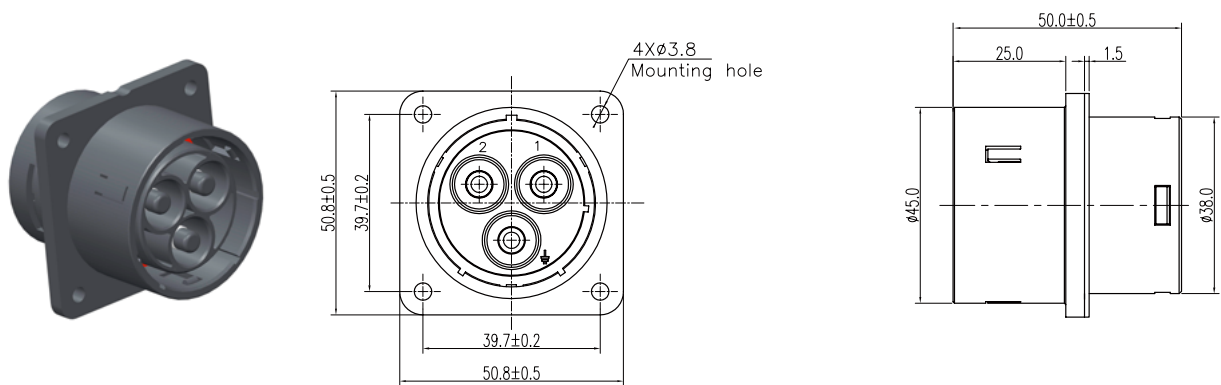

PLUG

P/N: XCEL6L2803ESCXXLC

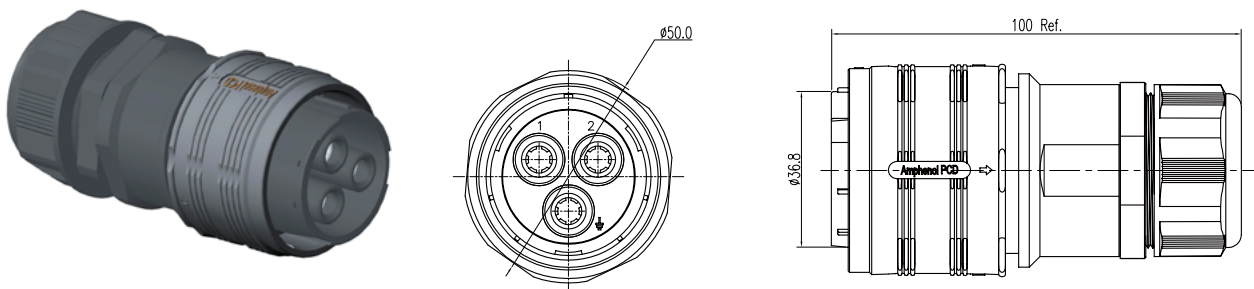

Technical data

Insert arrangement	28-03
Rated voltage	AC 500V
Rated current	63A
Contacts	3 X #4
Crimping cable	8 to 16mm ²

28-05: 500V / 45A , 5 PIN CONNECTOR

RECEPTACLE

P/N: XCEL3A2805EPCLC

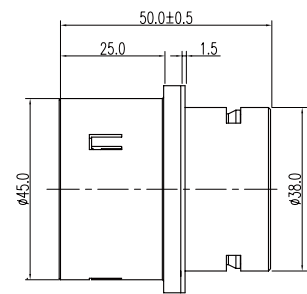
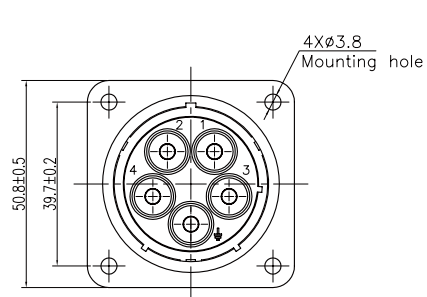

PLUG

P/N: XCEL6L2805ESCXXLC

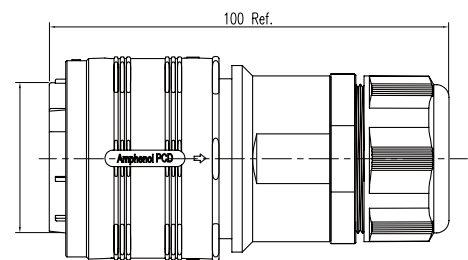
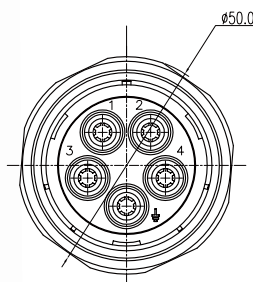

Technical data

Insert arrangement	28-05
Rated voltage	AC 500V
Rated current	45A
Contacts	5 X #8
Crimping cable	5 to 6mm ²

CONTACTS



	插针	插孔
#12	<p>C420027011</p>	<p>C420027013</p>
#8	<p>C420027008</p>	<p>C420027009</p>
	<p>C420027004</p>	<p>C420027005</p>
#4	<p>C42002710001</p>	<p>C42002710101</p>

TOOLS

Contact Size	Part Number		Plateing	Cable	Tools		
	Pin	Socket			Crimping tool	Insertion tool	Extraction tool
#12	C420027011	C420027013	Silver (Gold)	1.0 to 2.5mm ²	M22520/1-01	M81969/14-04	M15570-12
#8	C420027004	C420027005	Silver (Gold)	8.0 to 10mm ²	APHWA23KIT	ASGTC-I-8	ASGTC-R-8
	C420027008	C420027009	Silver (Gold)	5.0 to 6.0mm ²	APHWA23KIT	M81969/14-06	M81969/29-02
#4	C42002710001	C42002710101	Silver (Gold)	8.0 to 16mm ²	APHWA23KIT	M81969/14-07	M81969/29-03

#12 Crimping tool M22520/1-01 	#12 Insertion tool M81969/14-04 	#12 Extraction tool M15570-12 
#8 Crimping tool APHWA23KIT 	#8 Insertion tool ASGTC-I-8 	#8 Extraction tool ASGTC-R-8 
#8 Crimping tool APHWA23KIT 	#8 Insertion tool M81969/14-06 	#8 Extraction tool M81969/29-02 
#4 Crimping tool APHWA23KIT 	#4 Insertion tool M81969/14-07 	#4 Extraction tool M81969/29-03 

Amphenol PCD Shenzhen

Building 21
1st Liao Keng Industrial Zone
Shi Yan Street, Bao An District Shenzhen 518108
China

Tel.: +86 755-8173-8000
Fax: +86 755-8173-8180

www.amphenolpcd.com.cn

Notes:

Amphenol PCD Shenzhen has made every effort to ensure that the information contained in this catalog is accurate at the time of publication. Specifications or information stated in this publication are subject to change without notice.

Amphenol PCD Shenzhen reserves the right to clarify this catalog.